

E-TRAC ***Xchange***

User Guide





A significant feature of E-Trac is the inclusion of a USB connection facility, allowing you to connect your E-Trac to a Personal Computer (PC) to download and upload detector User Modes, Discrimination Patterns and Settings for optimum performance.

The Xchange program allows you to modify the settings of the detector and either save them to your PC, or upload them into your E-Trac. You can download, save and upload Discrimination Patterns but you cannot edit them on your PC.

User Modes and Discrimination Patterns that you have modified while detecting in the field can be downloaded from the E-Trac to your PC. This means you can save all of your favourite User Modes for your favourite detecting locations. When you want to go detecting in these locations again you can upload these User Modes and Discrimination Patterns into your detector and you will be ready to go!

You can also save a Backup of all your E-Trac's User Modes, Discrimination Patterns and Settings to your PC. Saving a Backup of your E-Trac will ensure you can restore all of your detector settings if the need arises.

The User Modes, Discrimination Patterns and Backups saved to your PC can be Xchanged with other detectorists. There is no limit to the number of saved User Mode, Universal Setting or Discrimination Pattern files that you can have on your PC.

E-Trac Xchange is versatile and easy to use, so make the most of your E-Trac with this great new feature. Enjoy!

2	Introduction
4	Installing E-Trac Xchange
5	Starting E-Trac Xchange
6	Introduction to E-Trac Xchange
8	E-Trac Xchange Mode Settings
9	Downloading Mode Settings
10	Saving and Opening Mode Settings
11	Uploading Mode Settings
12	Saving a Mode Pattern
13	E-Trac Xchange Universal Settings
14	Downloading Universal Settings
15	Saving and Opening Universal Settings
16	Uploading Universal Settings
17	E-Trac Xchange Preferences
18	Downloading Preferences
19	Uploading Preferences
20	E-Trac Xchange Patterns
21	Downloading Patterns
22	Saving Patterns
23	Uploading Patterns
24	E-Trac Xchange Backup
24	Creating a Backup file
24	Opening a Backup file
25	Restoring a Backup file
26	E-Trac Xchange Help
27	Minelab Contacts

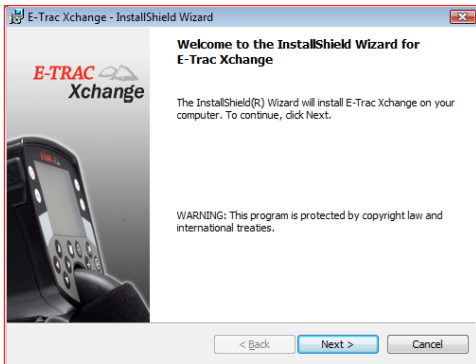

System Requirements:

- Windows 2000, Windows XP or Windows Vista
- Minimum display resolution of 1024 x 768
- USB or USB 2.0 port
- USB Data Cable (included with your E-Trac)

To install E-Trac Xchange on your PC:

- 1 Insert the CD (included with your E-Trac) into the CD/DVD drive of your PC.
- 2 The CD will auto-run once inserted into your PC and the Install Wizard will launch.
- 3 Follow the install prompts to install E-Trac Xchange onto your PC.

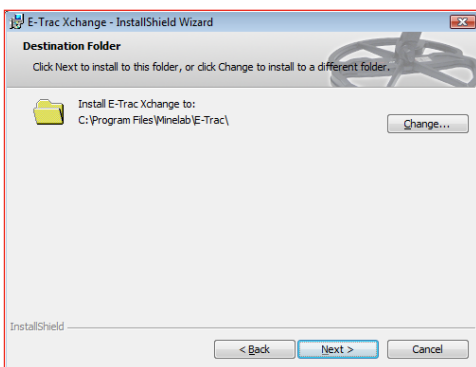

Once you have installed E-Trac Xchange on your PC you can select to start the application automatically at the end of the installation. You may also close the Install Wizard and choose to start E-Trac Xchange from either the Start Menu or the shortcut on your Desktop.

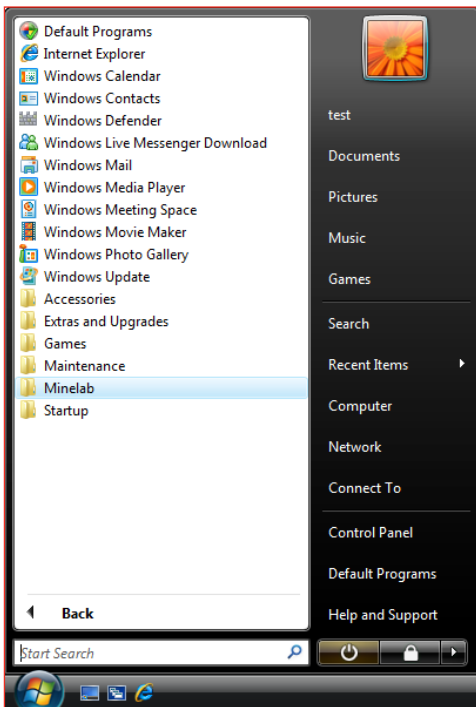

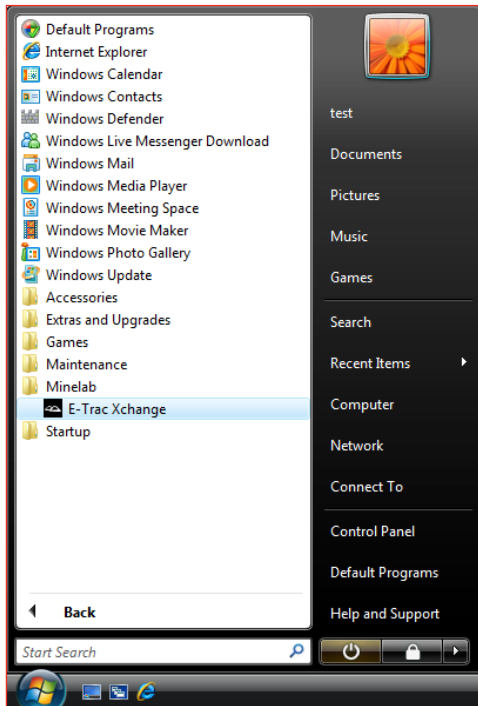

To start the E-Trac Xchange application:

- 1 Double click the E-Trac Xchange application icon on your desktop, or open your Start Menu and navigate to: All Programs – Minelab – E-Trac Xchange

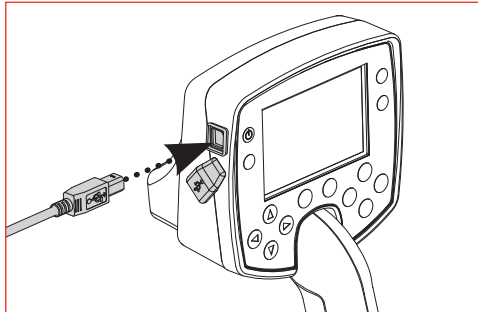

To connect E-Trac to your PC:

- 1 Insert the USB cable into your E-Trac
- 2 Insert the other end of the USB cable into your PC
- 3 Start E-Trac Xchange on your PC
- 4 Although E-Trac's transmitter is switched off while connected to a PC, make sure the coil is not sitting next to any large metal objects, then turn on your E-Trac

The coil may still pick up noise from the surrounding environment while connected to your PC. The detector may treat this as a target detection.

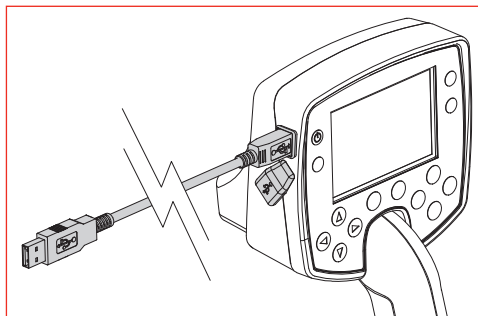

To disconnect E-Trac from your PC

- 1 Exit E-Trac Xchange via the 'File' drop-down menu at the top of the screen
- 2 Turn your E-Trac Off
- 3 Disconnect the USB cable from your PC
- 4 Disconnect the USB cable from your E-Trac

E-Trac's settings can be divided into three groups: Mode Settings, Universal Settings and Preferences. The E-Trac Xchange screen layout groups these settings to allow you to easily identify which group the setting belongs to.

This is the first screen displayed when you start E-Trac Xchange.

File, Backup and Help

E-Trac Xchange application drop-down menus. "File" allows you to exit, "Backup" allows you to backup Modes, Settings and Patterns, and "Help" allows you to access this User Guide, the E-Trac Instruction Manual, Minelab website and your email, so you may contact Minelab.

Mode Settings

User Mode settings from E-Trac can be downloaded, saved, changed and uploaded using these settings and buttons.

Universal Settings

Settings from E-Trac other than User Modes and Preferences can be downloaded, saved, changed and uploaded using these settings and buttons.

Preferences

The Preferences settings from E-Trac can be downloaded, saved, changed and uploaded using these settings and buttons.

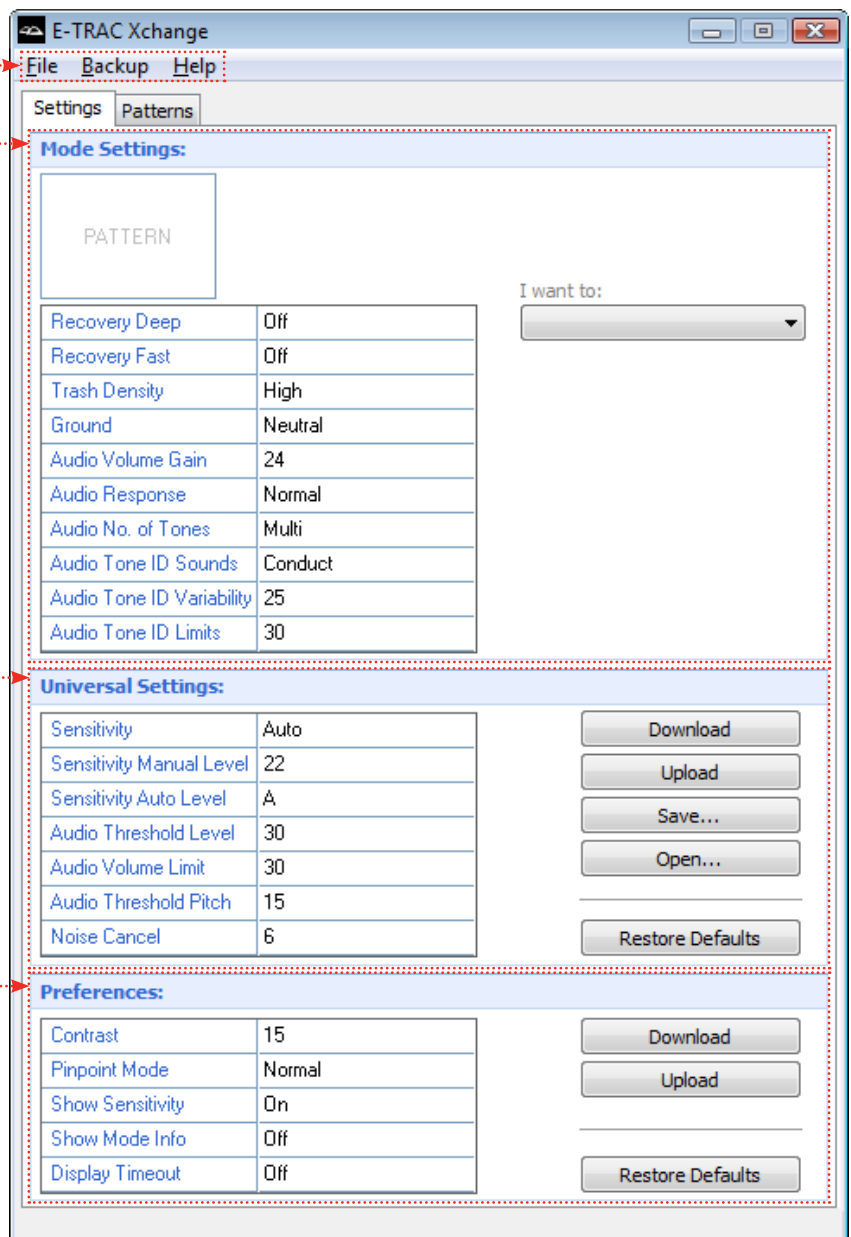



Download

- This button will download data from E-Trac into Xchange. If you click "Download" then the settings displayed in Xchange will be updated to display the settings in your E-Trac.



Upload

- This button will upload data from Xchange into E-Trac. If you click "Upload" then the settings displayed in your E-Trac will be updated to display the settings in Xchange.



Save...

- This button will save data from Xchange into a file on your PC.



Open...

- This button will open data from a file on your PC into Xchange. To upload that data into your E-Trac you must follow the relevant instructions for those settings i.e. Mode, Universal or Preferences.



Restore Defaults

- This button will restore Xchange settings to their Factory Presets. Factory Presets for Xchange are the same as the Factory Presets for your E-Trac.

Note: For more information on E-Trac's Factory Presets see the Factory Presets Table on pp. 82–3 of the E-Trac Instruction Manual.

Mode Settings:

PATTERN

Recovery Deep	Off
Recovery Fast	Off
Trash Density	High
Ground	Neutral
Audio Volume Gain	24
Audio Response	Normal
Audio No. of Tones	Multi
Audio Tone ID Sounds	Conduct
Audio Tone ID Variability	25
Audio Tone ID Limits	30

I want to:

PATTERN

Recovery Deep	Off
---------------	-----

Recovery Fast	Off
---------------	-----

Trash Density	High
---------------	------

Ground	Neutral
--------	---------

Audio Volume Gain	24
-------------------	----

Audio Response	Normal
----------------	--------

Audio No. of Tones	Multi
--------------------	-------

Audio Tone ID Sounds	Conduct
----------------------	---------

Audio Tone ID Variability	25
---------------------------	----

Audio Tone ID Limits	30
----------------------	----

Mode Settings

These settings define E-Trac’s performance for a particular location (such as the beach) or type of treasure hunting (such as coins or relics). E-Trac is designed to allow you to save these Mode Settings as a User Mode. A User Mode can be saved in, or retrieved from, E-Trac memory; or shared with another user via E-Trac Xchange

Discrimination Pattern

The Discrimination Pattern currently attached to the User Mode you have either loaded from a file, or downloaded from E-Trac. You can right-click on the Pattern to “Save Pattern...” to a file.

Recovery Deep

Click on ‘Off’ to expose the drop-down options for Recovery Deep. See p. 70 of the E-Trac Instruction Manual for more information on Recovery Deep.

Recovery Fast

Click on ‘Off’ to expose the drop-down options for Recovery Fast. See p. 71 of the E-Trac Instruction Manual for more information on Recovery Fast.

Trash Density

Click on ‘High’ to expose the drop-down options for Trash Density. See p. 72 of the E-Trac Instruction Manual for more information on Trash Density.

Ground

Click on ‘Neutral’ to expose the drop-down options for Ground. See p. 74 of the E-Trac Instruction Manual for more information on Ground.

Audio Volume Gain

Click on ‘24’ to enter a different Volume Gain (range: 1–30). See p. 61 of the E-Trac Instruction Manual for more information on Volume Gain.

Audio Response

Click on ‘Normal’ to expose the drop-down options for Response. See p. 62 of the E-Trac Instruction Manual for more information on Response.

Audio No. of Tones

Click on ‘Multi’ to expose the drop-down options for No. of Tones. See p. 64 of the E-Trac Instruction Manual for more information on No. of Tones.

Audio Tone ID Sounds

Click on ‘Conduct’ to expose the drop-down options for Sounds. See p. 65 of the E-Trac Instruction Manual for more information on Sounds.

Audio Tone ID Variability

Click on ‘25’ to enter a different Variability (range: 1–30) See p. 67 of the E-Trac Instruction Manual for more information on Variability.

Audio Tone ID Limits

Click on ‘30’ to enter a different Limits (range: 1–30) See p. 68 of the E-Trac Instruction Manual for more information on Limits.

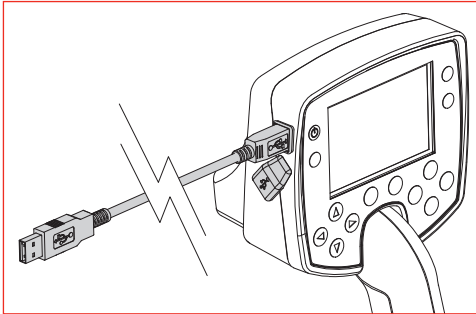

Xchange allows you to download either the current User Mode, one of your saved My Modes or one of the Minelab User Modes.

To Download User Mode settings from E-Trac:

- 1 Ensure you have started E-Trac Xchange
- 2 Connect your E-Trac to your PC via the USB cable
- 3 Turn on your E-Trac
- 4 In Xchange, click on the “I want to:” drop-down menu and click on the “Download Mode from E-Trac” option
- 5 A new drop-down menu will appear asking you to select the Mode you wish to download
- 6 Select your desired Mode
- 7 Click Download

The Mode Settings section of Xchange will update when the User Mode and Discrimination Pattern are downloaded from your E-Trac.

Once E-Trac Xchange has downloaded the Mode Settings from your E-Trac you can then do several other actions. You may choose to save these settings in a file, or modify the settings and upload them to your E-Trac.

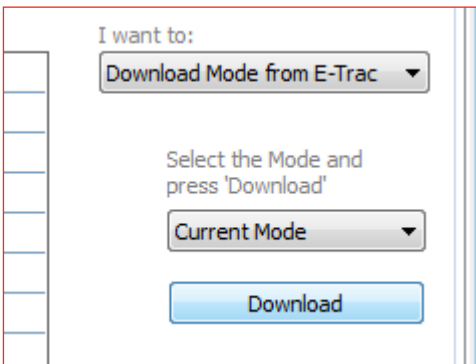
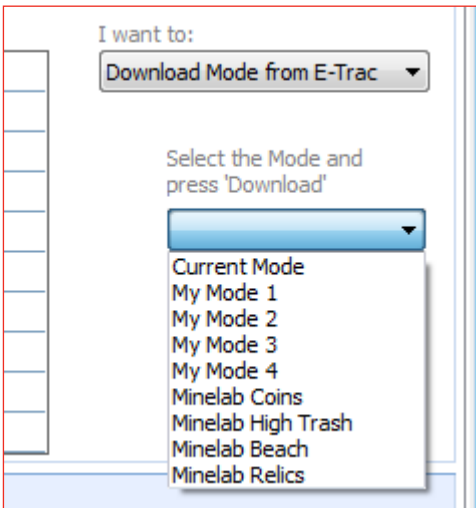
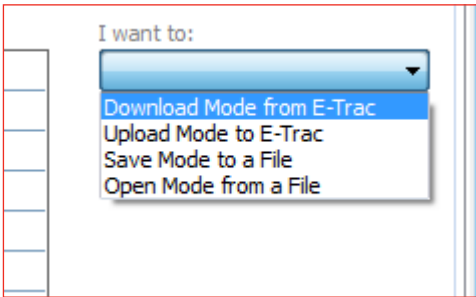

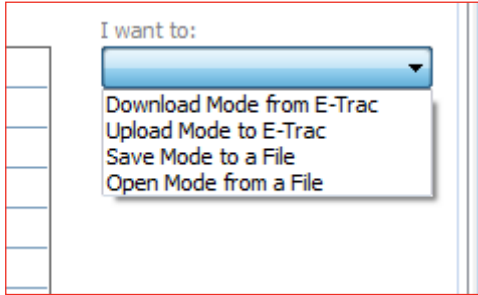

Saving Mode Settings to your PC

Once you have downloaded a User Mode from your E-Trac you can save this Mode as a file. A Mode saved in a file on your PC is an excellent way of backing up your User Modes, so that you may upload any one of them to your E-Trac in the future.

There is no limit to the number of saved User Mode files that you can have on your PC. All saved User Modes will have the file extension ".mode" at the end of the file name.

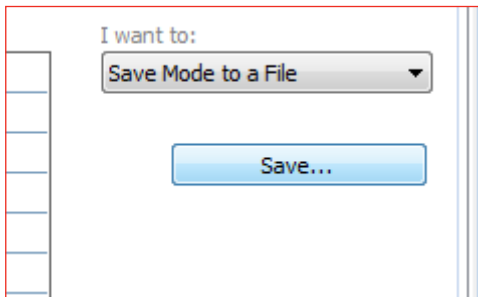

To Save Mode Settings:

- 1 In the Mode Settings section, click on the "I want to:" drop-down menu and click on the "Save Mode to a file" option
- 2 Click Save
- 3 The Save dialogue will appear allowing you to name your Mode and choose where to save it on your PC
- 4 Click Save

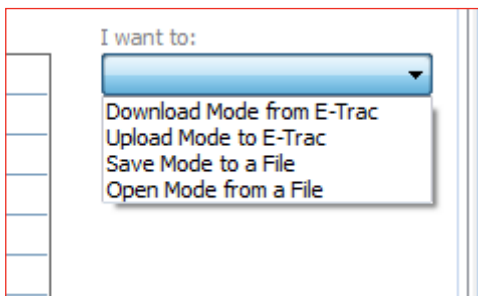

Opening saved Mode Settings into Xchange

You can open one of your saved Mode Settings into E-Trac Xchange anytime you want. All saved User Modes will have the file extension ".mode" at the end of the file name.

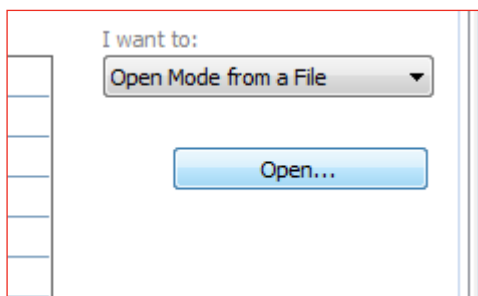

To Open saved Mode Settings:

- 1 In the Mode Settings section, click on the "I want to:" drop-down menu and click on the "Open Mode from a File" option
- 2 Click Open
- 3 The Open dialogue will appear allowing you to locate your saved Mode Settings on your PC
- 4 Click Open

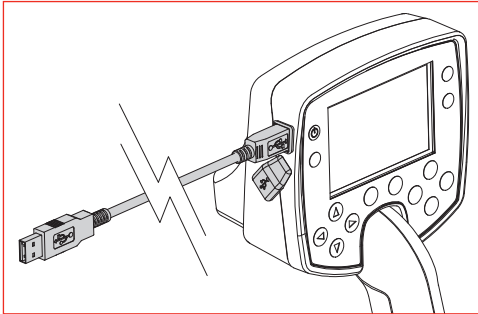

Xchange allows you to upload the current Mode Settings to your E-Trac. You must first change Mode Settings in Xchange, or open a saved User Mode in Xchange before uploading to your E-Trac.

To Upload Mode Settings to E-Trac:

- 1 Ensure you have started E-Trac Xchange
- 2 Connect your E-Trac to your PC via the USB cable
- 3 Turn on your E-Trac
- 4 In Xchange, click on the “I want to:” drop-down menu and click on the “Upload Mode to E-Trac” option
- 5 A new drop-down menu will appear asking you to select the slot you wish to upload to. You can upload to either the “Current Mode” slot or one of the four “My Mode” slots
- 6 Select your desired User Mode slot
- 7 Click Upload. If the Mode slot is already occupied a warning message will appear asking you to confirm your upload, click “Yes” to confirm or “Cancel” to cancel the upload.

You can view the uploaded User Mode in your E-Trac while it is connected to your PC. If you have uploaded to a slot other than the “Current Mode”, you can select that User Mode in your E-Trac in order to view its settings. By doing this you can check that the User Mode has uploaded correctly.

Once E-Trac Xchange has uploaded the Mode Settings from your PC to your E-Trac you can then use this User Mode when you next go detecting with your E-Trac.

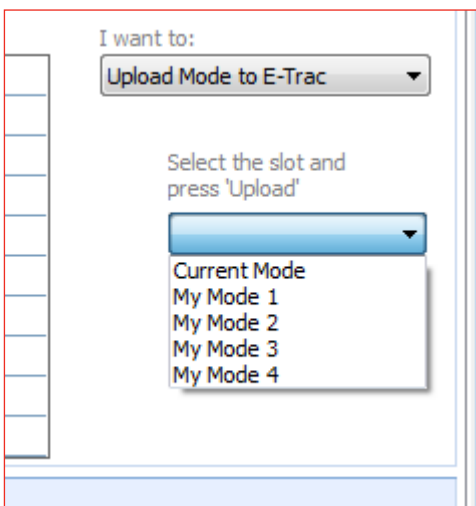
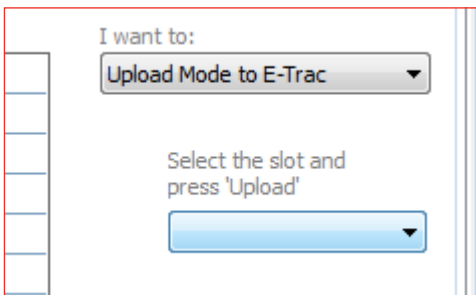
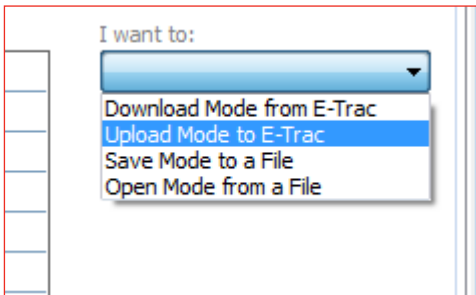

When you download User Mode settings from your E-Trac a Discrimination Pattern linked to that User Mode will also be downloaded. The Discrimination Pattern will appear as a thumbnail image at the top of the Mode Settings.

You can save a Mode Pattern as a file, separate from a general Mode Settings file.

There is no limit to the number of saved Discrimination Pattern files that you can have on your PC. All saved Discrimination Patterns will have the file extension “.ptrn” at the end of the file name.

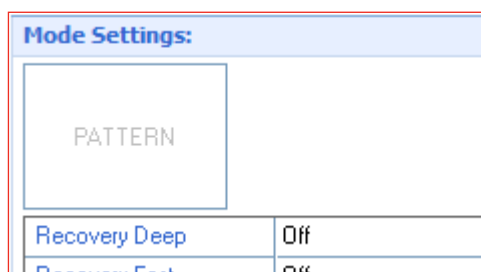

To Save a Mode Pattern:

- 1 In the Mode Settings section, right click on the Pattern thumbnail
- 2 Click on the “Save Pattern...” pop-up option that appears
- 3 The Save Pattern dialogue will appear allowing you to name your Discrimination Pattern and choose where to save it on your PC
- 4 Click Save

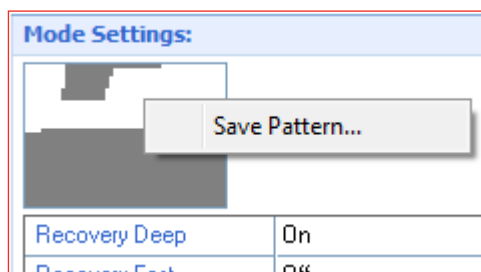

Note: See pp. 20–3 for more information on what you can do with your patterns in E-Trac Xchange.

Universal Settings:	
Sensitivity	Auto
Sensitivity Manual Level	22
Sensitivity Auto Level	A
Audio Threshold Level	30
Audio Volume Limit	30
Audio Threshold Pitch	15
Noise Cancel	6

Download
Upload
Save...
Open...
Restore Defaults

Sensitivity	Auto
-------------	------

Sensitivity Manual Level	22
--------------------------	----

Sensitivity Auto Level	A
------------------------	---

Audio Threshold Level	30
-----------------------	----

Audio Volume Limit	30
--------------------	----

Audio Threshold Pitch	15
-----------------------	----

Noise Cancel	6
--------------	---

Universal Settings

These settings affect E-Trac's performance but can be adjusted regardless of your location and desired treasure type. Universal Settings are determined according to your personal detecting choices (e.g. Sensitivity, Noise Cancel and Threshold Pitch), and are changed independent of your Mode Settings.

Sensitivity

Click on 'Auto' to expose the drop-down options for Sensitivity. See pp. 54–6 of the E-Trac Instruction Manual for more information on Sensitivity.

Sensitivity Manual Level

Click on '22' to enter a different Sensitivity Manual Level (range: 1–30). See p. 56 of the E-Trac Instruction Manual for more information on Sensitivity Manual Level.

Sensitivity Auto Level

Click on 'A' to enter a different Sensitivity Auto Level (range: –3 – +3). See p. 55 of the E-Trac Instruction Manual for more information on Sensitivity Auto Level.

Audio Threshold Level

Click on '30' to enter a different Audio Threshold Level (range: 1–50). See p. 58 of the E-Trac Instruction Manual for more information on Audio Threshold Level.

Audio Volume Limit

Click on '30' to enter a different Audio Volume Limit (range: 0–30). See p. 60 of the E-Trac Instruction Manual for more information on Audio Volume Limit.

Audio Threshold Pitch

Click on '15' to enter a different Audio Threshold Pitch (range: 1–30). See p. 69 of the E-Trac Instruction Manual for more information on Audio Threshold Pitch.

Noise Cancel

Click on '6' to enter a different Noise Cancel channel (range: 1–11). See p. 31 and p. 74 of the E-Trac Instruction Manual for more information on Noise Cancel.

Xchange allows you to download the Universal Settings from your E-Trac.

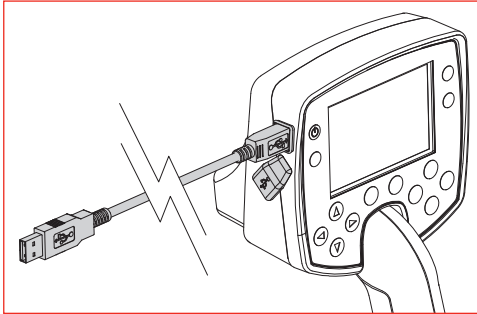

To Download Universal Settings from E-Trac:

- 1 Ensure you have started E-Trac Xchange
- 2 Connect your E-Trac to your PC via the USB cable
- 3 Turn on your E-Trac
- 4 In the Universal Settings section of Xchange, click on the "Download" button

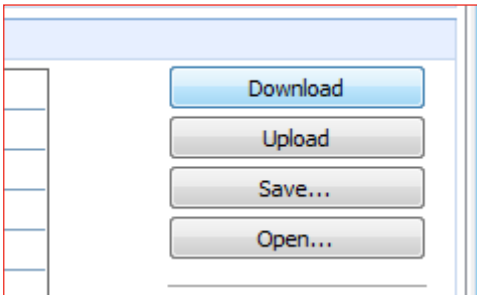

Once E-Trac Xchange has downloaded the Universal Settings from your E-Trac you can then do several other actions. You may choose to save these settings in a file, or modify the settings and upload them to your E-Trac.

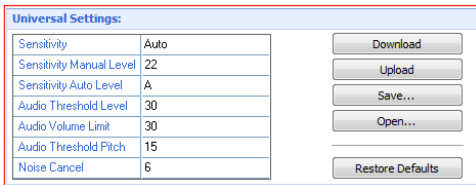

Saving Universal Settings to your PC

Once you have downloaded Universal Settings from your E-Trac you can save these settings as a file. Universal Settings saved in a file on your PC is an excellent way of backing up your Universal Settings, so that you may upload any saved configuration to your E-Trac in the future.

There is no limit to the number of saved Universal Settings files that you can have on your PC. All saved Universal Settings will have the file extension ".glb" at the end of the file name.

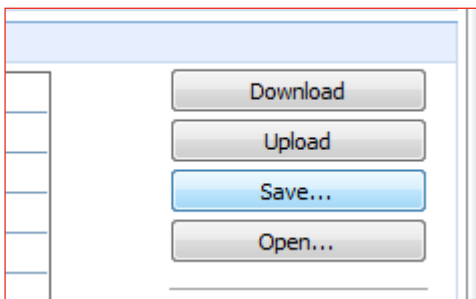

To Save Universal Settings:

- 1 In the Universal Settings section, click on the "Save..." button
- 2 The Save dialogue will appear allowing you to name your Universal Settings and choose where to save it on your PC
- 3 Click Save

Opening saved Universal Settings into Xchange

You can open your saved Universal Setting files into E-Trac Xchange anytime you want. All saved Universal Settings will have the file extension ".glb" at the end of the file name.

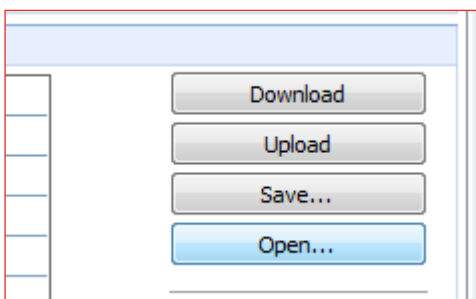

To Open saved Universal Settings:

- 1 In the Universal Settings section, click on the "Open..." button
- 2 The Open dialogue will appear allowing you to locate your saved Universal Settings on your PC
- 3 Click Open

Xchange allows you to upload the current Universal Settings to your E-Trac. You must first change Universal Settings in Xchange, or open saved Universal Settings into Xchange before uploading to your E-Trac.

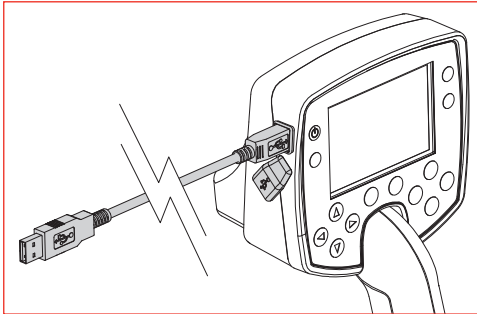

To Upload Universal Settings to E-Trac:

- 1 Ensure you have started E-Trac Xchange
- 2 Connect your E-Trac to your PC via the USB cable
- 3 Turn on your E-Trac
- 4 In Xchange, in the Universal Settings section, click on the "Upload" button

You can view the uploaded Universal Settings in your E-Trac while it is connected to your PC. By doing this you can check that the Universal Settings have uploaded correctly.

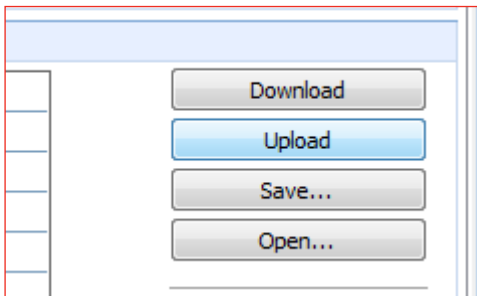

Once E-Trac Xchange has uploaded the Universal Settings from your PC to your E-Trac you can then use these settings when you next go detecting with your E-Trac.

Preferences:	
Contrast	15
Pinpoint Mode	Normal
Show Sensitivity	On
Show Mode Info	Off
Display Timeout	Off

Download
Upload
Restore Defaults

Contrast	15
----------	----

Pinpoint Mode	Normal
---------------	--------

Show Sensitivity	On
------------------	----

Show Mode Info	Off
----------------	-----

Display Timeout	Off
-----------------	-----

Preferences

These settings allow you to customize the appearance of the Detection Screens (e.g. Contrast and Show Sensitivity) and change the Pinpoint Mode.

Contrast

Click on '15' to enter a different Contrast value (range: 1–30). See p. 76 of the E-Trac Instruction Manual for more information on Contrast.

Pinpoint Mode

Click on 'Normal' to expose the drop-down options for Pinpoint Mode. See pp. 76–7 of the E-Trac Instruction Manual for more information on Pinpoint Modes.

Show Sensitivity

Click on 'On' to expose the drop-down options for Show Sensitivity. See p. 78 of the E-Trac Instruction Manual for more information on Show Sensitivity.

Show Mode Info

Click on 'Off' to expose the drop-down options for Show Mode Info. See p. 78 of the E-Trac Instruction Manual for more information on Show Mode Info.

Display Timeout

Click on 'Off' to expose the drop-down options for Display Timeout. See p. 79 of the E-Trac Instruction Manual for more information on Display Timeout.

Xchange allows you to download the Preferences from your E-Trac.

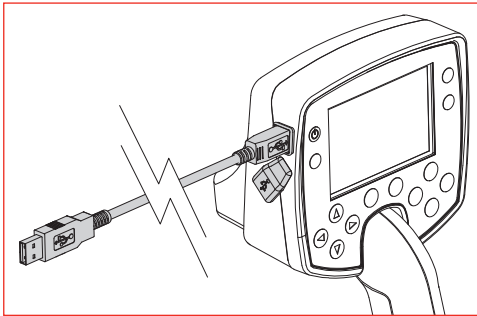

To Download Preferences from E-Trac:

- 1 Ensure you have started E-Trac Xchange
- 2 Connect your E-Trac to your PC via the USB cable
- 3 Turn on your E-Trac
- 4 In the Preferences section of Xchange, click on the "Download" button

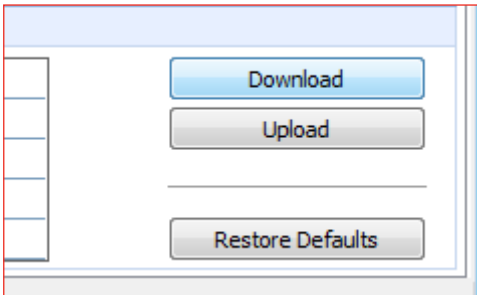

Once E-Trac Xchange has downloaded the Preferences from your E-Trac you can then modify these settings and upload them to your E-Trac.

Xchange allows you to upload the current Preferences to your E-Trac. You must first change Preferences in Xchange before uploading to your E-Trac.

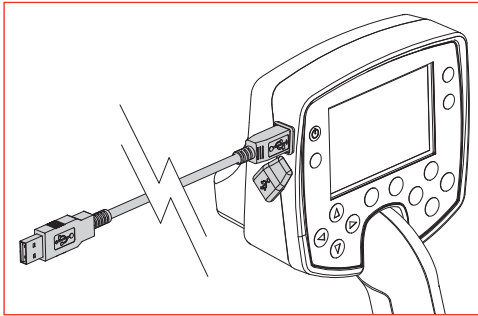

To Upload Preferences to E-Trac:

- 1 Ensure you have started E-Trac Xchange
- 2 Connect your E-Trac to your PC via the USB cable
- 3 Turn on your E-Trac
- 4 In Xchange, in the Preferences section, click on the “Upload” button

You can view the uploaded Preferences in your E-Trac while it is connected to your PC. By doing this you can check that the Preferences have uploaded correctly.

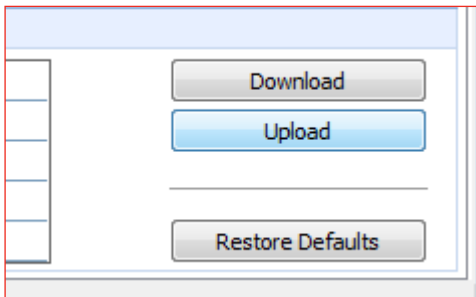

Once E-Trac Xchange has uploaded the Preferences from your PC to your E-Trac you can then use these settings when you next go detecting with your E-Trac.

E-Trac's Discrimination Patterns can be divided into three groups: Current Patterns, My Patterns and My Mode Patterns. The E-Trac Xchange screen layout groups these Disc. Patterns to allow you to easily identify which group the Disc. Pattern belongs to.

This is the screen displayed when you select the "Patterns" tab in E-Trac Xchange.

File, Backup and Help

E-Trac Xchange application drop-down menus. "File" allows you to exit, "Backup" allows you to backup Modes, Settings and Patterns, and "Help" allows you to access this User Guide, the E-Trac Instruction Manual, Minelab website and your email so you may contact Minelab.

"I want to:"

This drop-down menu allows you to download or upload Discrimination Patterns from or to your E-Trac.

Current Patterns

These Discrimination Patterns are those you are currently using in your E-Trac's Smartfind and QuickMask. Smartfind Disc. Patterns can be active in either the Detect, Digital or Edit Screens.

My Patterns

These Discrimination Patterns are those you have stored in the Discrimination "Save" sub-Menu of your E-Trac. Factory Preset Disc. Patterns cannot be downloaded, nor overwritten when you upload.

My Mode Patterns

These Discrimination Patterns are those you have attached to your "User Modes". Factory Preset "Minelab Modes" Disc. Patterns cannot be downloaded, nor overwritten when you upload.

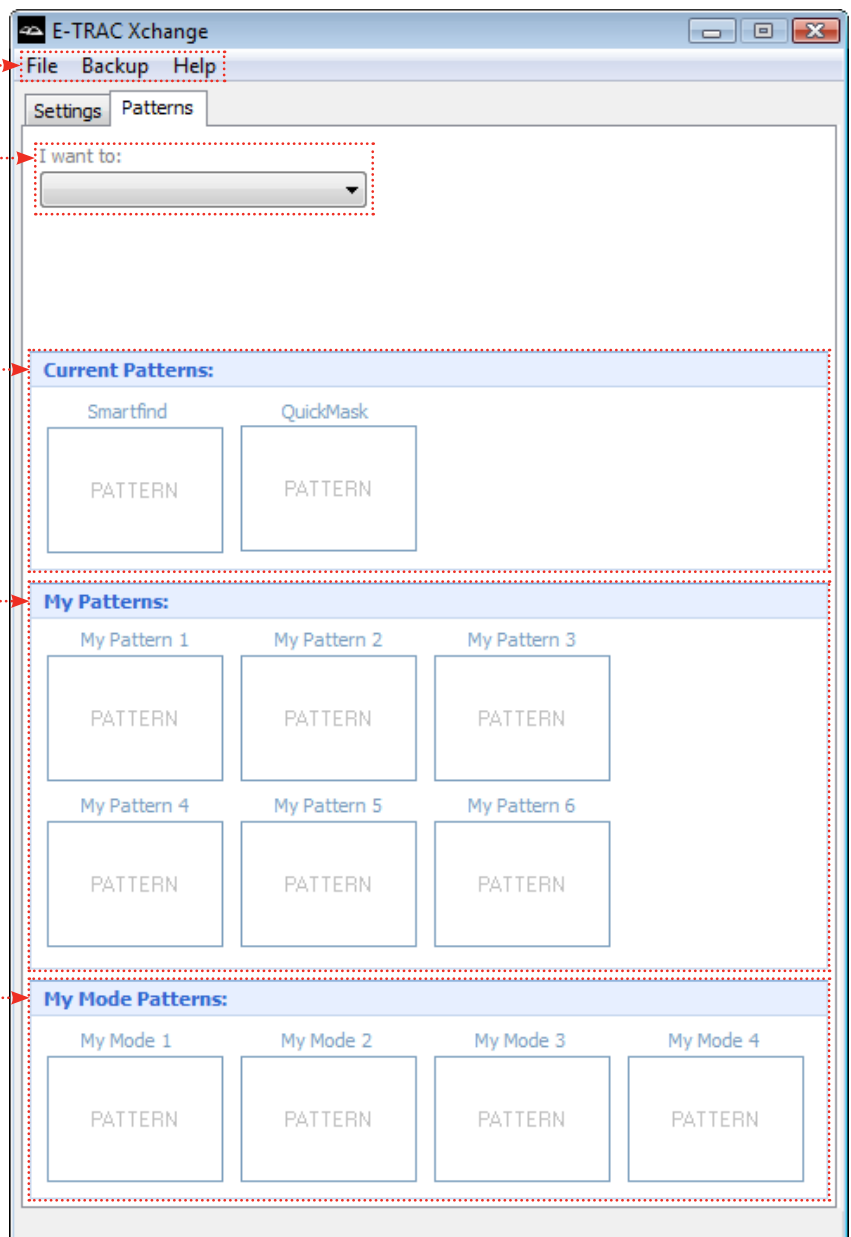

Xchange allows you to download all of your Discrimination Patterns stored on your E-Trac. This includes your current Smartfind and QuickMask Patterns, My Patterns and My Mode Patterns.

To Download Patterns from E-Trac:

- 1 Ensure you have started E-Trac Xchange
- 2 Connect your E-Trac to your PC via the USB cable
- 3 Turn on your E-Trac
- 4 In Xchange, click on the "Patterns" tab at the top of the screen
- 5 In the Patterns screen, click on the "I want to:" drop-down menu and click on "Download all patterns from E-Trac"
- 6 Click the Download All button

The thumbnail Discrimination Pattern slots in Xchange will update to display the corresponding Disc. Patterns stored in your E-Trac.

If you do not have any Disc. Patterns saved as "My Pattern..." or "My Mode..." in your E-Trac, then no Disc. Patterns will be displayed in Xchange after you Download All.

Once E-Trac Xchange has downloaded the Discrimination Patterns from your E-Trac you may choose to save these Disc. Patterns in a file, or upload Patterns saved on your PC to your E-Trac.

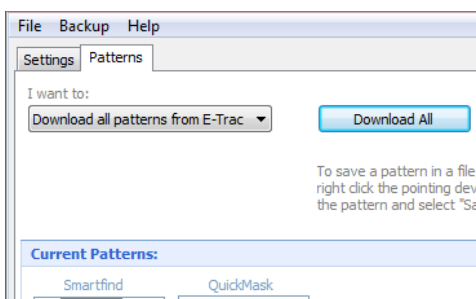
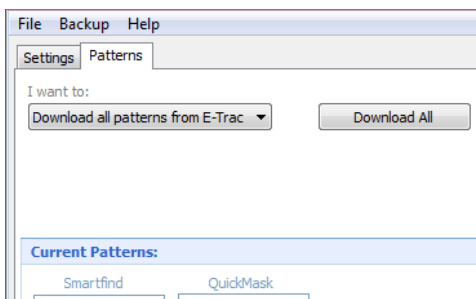
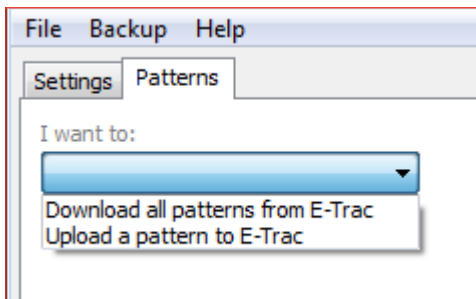

When you download Discrimination Patterns from your E-Trac, thumbnail images of your Discrimination Patterns will appear.

You can save your downloaded Discrimination Patterns as files on your PC.

There is no limit to the number of saved Discrimination Pattern files that you can have on your PC. All saved Discrimination Patterns will have the file extension “.ptrn” at the end of the file name.

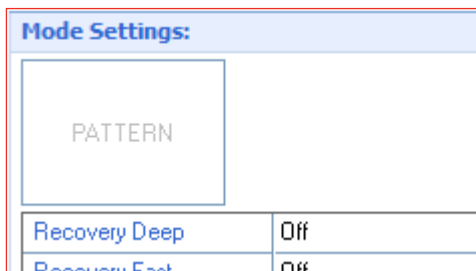

To Save a Pattern:

- 1 In the Pattern screen, right click on the Pattern thumbnail you wish to save
- 2 Click on the “Save Pattern...” pop-up option that appears
- 3 The Save Pattern dialogue will appear allowing you to name your Discrimination Pattern and choose where to save it on your PC
- 4 Click “Save”

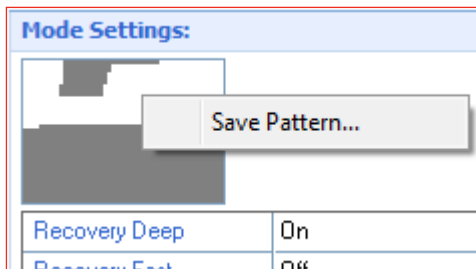

Xchange allows you to upload your Discrimination Patterns saved on your PC to your E-Trac. You can upload Disc. Patterns to your current Smartfind and QuickMask Patterns, My Patterns and My Mode Patterns.

To Upload Patterns to E-Trac:

- 1 Ensure you have started E-Trac Xchange
- 2 Connect your E-Trac to your PC via the USB cable
- 3 Turn on your E-Trac
- 4 In Xchange, click on the "Patterns" tab at the top of the screen
- 5 In the Patterns screen, click on the "I want to:" drop-down menu and click on "Upload a pattern to E-Trac"
- 6 Click the "Open" button
- 7 The Open dialogue will appear allowing you to locate your saved Disc. Patterns on your PC; click "Open" once you have done so
- 8 Click on the drop-down menu that appears under "2. Select the slot and press 'Upload'". Select the slot and press 'Upload' and select the slot in your E-Trac you wish to upload your Disc. Pattern to
- 9 Click "Upload"

You can view the uploaded Discrimination Patterns in your E-Trac while it is connected to your PC. By doing this you can check that the Disc. Pattern has uploaded correctly.

Once E-Trac Xchange has uploaded the Discrimination Patterns from your PC to your E-Trac you can then use these Disc. Patterns when you next go detecting with your E-Trac.

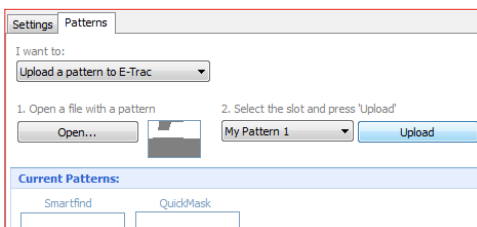
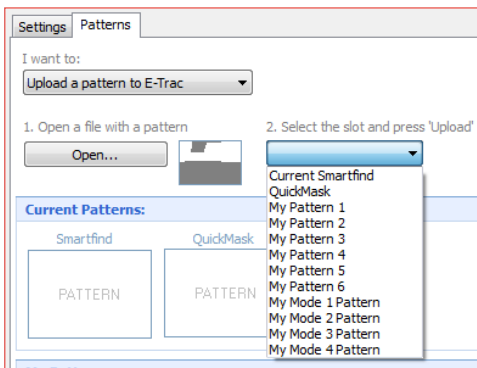
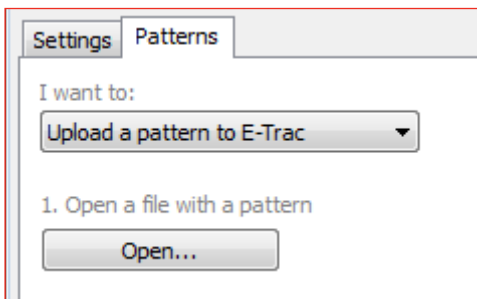
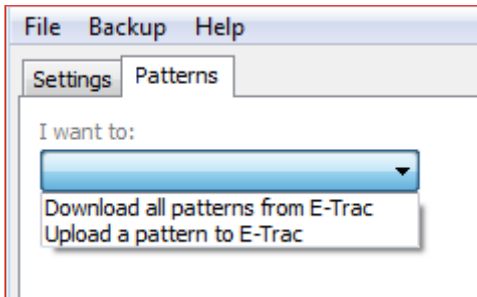

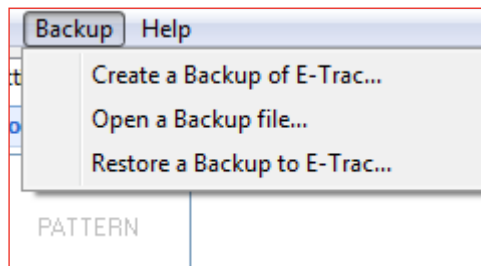

Creating a Backup file

E-Trac Xchange allows you to create a Backup of all of E-Trac's User Modes, Discrimination Patterns and Settings. A Backup is a file saved on your PC that you can open in E-Trac Xchange at anytime and use to restore your E-Trac.

There is no limit to the number of saved Backup files that you can have on your PC. All saved Backup files will have the file extension ".etrac" at the end of the file name.

To Create a Backup file:

- 1 Click on the "Backup" drop-down menu at the top of the screen.
- 2 Click on "Create a Backup of E-Trac..."
- 3 The Save dialogue will appear allowing you to name your Backup file and choose where to save it on your PC
- 4 Click "Save"

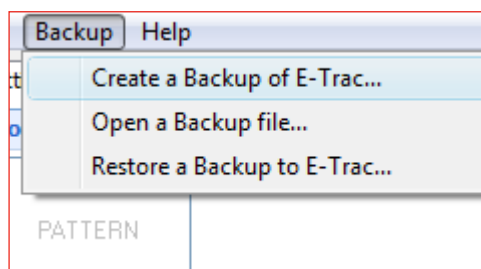

Opening a Backup file

If you have previously saved a Backup file on your PC you can open it in E-Trac Xchange at anytime. This allows you to view the settings stored in your Backup file, and make modifications to them, before restoring or uploading to your E-Trac.

To Open a Backup file:

- 1 Click on the "Backup" drop-down menu at the top of the screen.
- 2 Click on "Open a Backup file..."
- 3 The Open dialogue will appear allowing you to locate your saved Backup file on your PC
- 4 Click "Open"

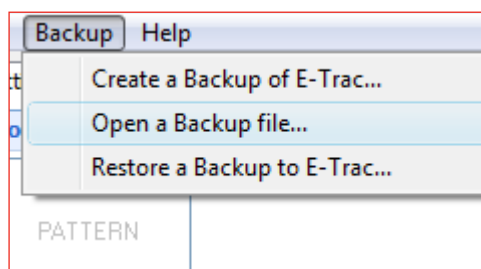
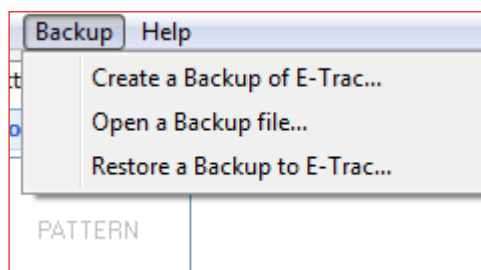

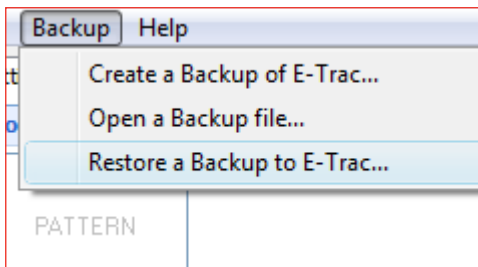
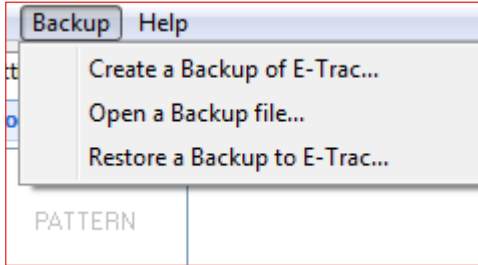

Restoring a Backup to E-Trac

If you have previously saved a Backup file of your E-Trac's settings you can restore those settings to your E-Trac.

Note: Minelab recommends that you view the settings saved in your Backup file, using the "Open a Backup file..." feature, before restoring your E-Trac. This will allow you to check that the Backup file has the settings you want.

To Restore a Backup to E-Trac:

- 1 Click on the "Backup" drop-down menu at the top of the screen.
- 2 Click on "Restore a Backup to E-Trac..."
- 3 The Open dialogue will appear allowing you to locate your saved Backup file on your PC
- 4 Click "Open". A warning message will appear asking you to confirm your Backup restore, click "Yes" to confirm or "No" to cancel the restore

Once you have restored your Backup file to your E-Trac, all of your User Modes, Discrimination Patterns and settings will match those that were saved in the Backup file.



Caution: Restoring a Backup file to your E-Trac will overwrite all saved User Modes, Discrimination Patterns and Settings currently stored on your E-Trac with those in the Backup file.

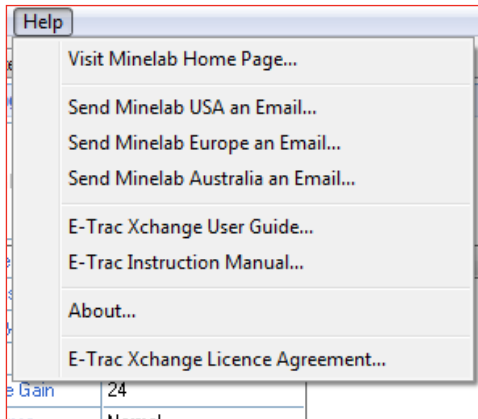

The E-Trac Xchange Help menu is where you can get access to both this User Guide and the E-Trac Instruction Manual. You can also visit the Minelab website, and send an email to Minelab.

Visit Minelab Home Page...

- Clicking “Visit Minelab Home Page...” will open your web browser and take you to the Minelab website, if you are connected to the internet.

Send Minelab USA an Email...

- Clicking “Send Minelab USA an Email...” will open a new email in your email program so that you may write to Minelab.

You have the choice of sending emails to either Minelab USA, Minelab Europe or Minelab Australia.

E-Trac Xchange User Guide...

- Clicking “E-Trac Xchange User Guide...” will open this PDF.

E-Trac Instruction Manual...

- Clicking “E-Trac Instruction Manual...” will open a PDF version of the E-Trac Instruction Manual that you received with your detector.

About...

- Clicking “About...” will bring up a small window in E-Trac Xchange that will tell you the software version number.

E-Trac Xchange Licence Agreement...

- Clicking “E-Trac Xchange Licence Agreement...” will open a PDF version of the E-Trac Xchange Licence Agreement.



Minelab Electronics Pty Ltd

PO Box 537, Torrensville Plaza
Adelaide, South Australia, 5031

Australia

Tel: +61 (0) 8 8238 0888

Fax: +61 (0) 8 8238 0890

Email: minelab@minelab.com.au



Minelab International Ltd

Laragh, Bandon
Co. Cork

Ireland

Tel: +353 (0) 23 52101

Fax: +353 (0) 23 52106

Email: minelab@minelab.ie

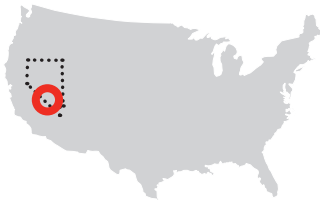

Minelab USA Inc

871 Grier Drive, Suite B1
Las Vegas, Nevada, 89119

USA

Tel: +1 702 891 8809

Fax: +1 702 891 8810

Email: info@minelabusa.com

Minelab is always interested in your opinions. If you have any questions or comments regarding the E-Trac or any other Minelab product, please feel free to contact us directly or via your local Authorised Minelab dealer.

For further product information and detecting tips, refer to:

WWW.MINELAB.COM